

S3 Credit Chapter 2 Similar Shapes: Working Backwards

1. In each of the following the pairs of shapes are similar. Find the unknown length.

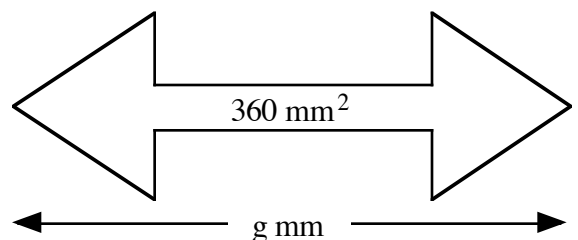

2. In each of the following the pairs of items are similar. Find the unknown lengths.

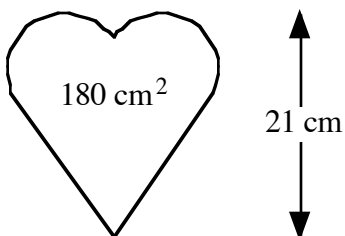
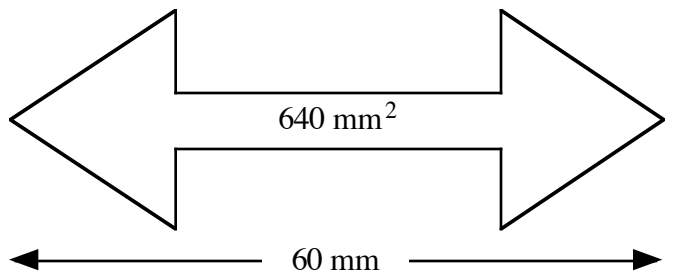
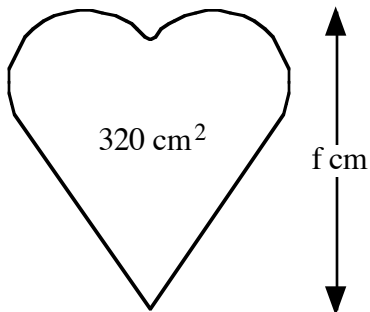
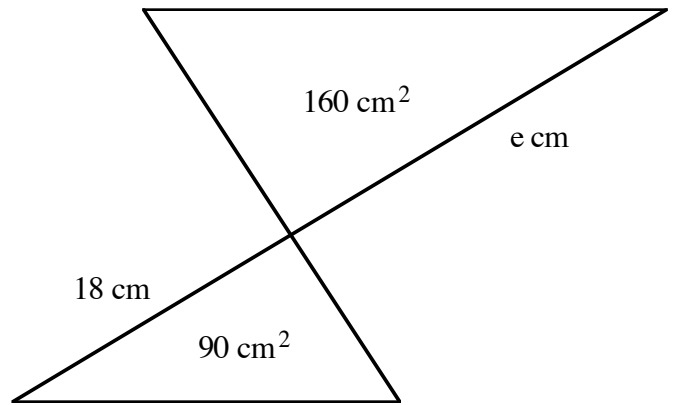
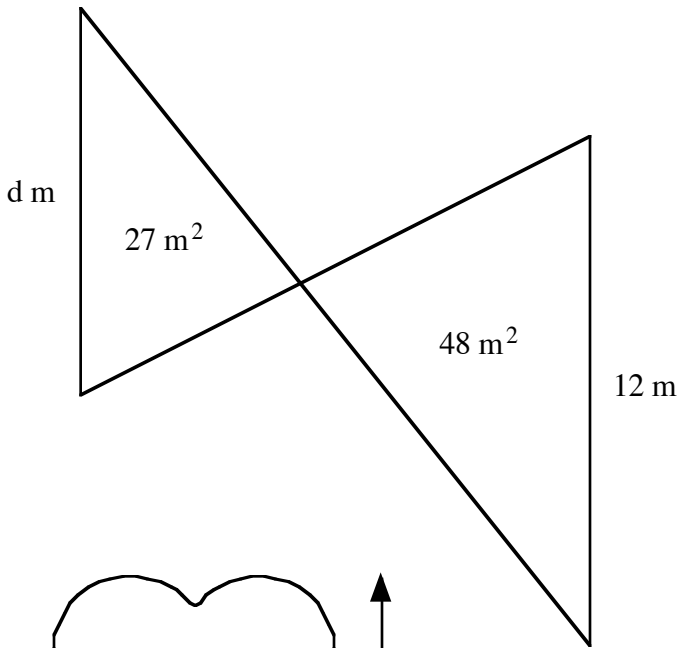
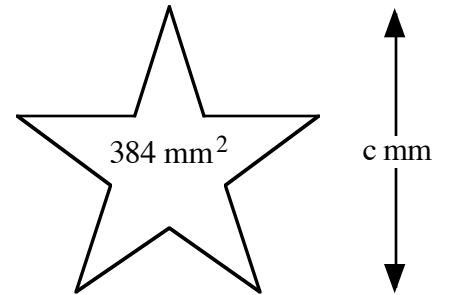
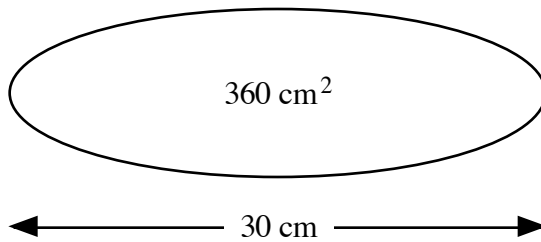
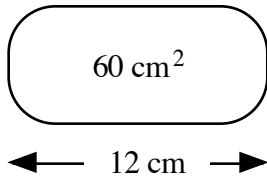
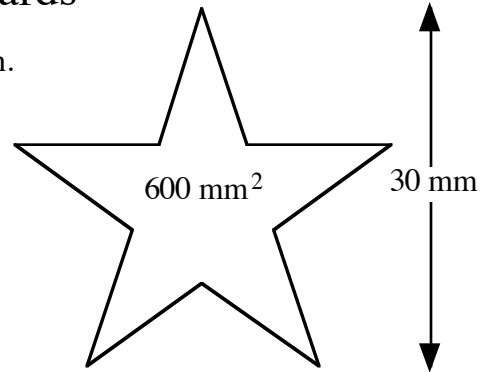
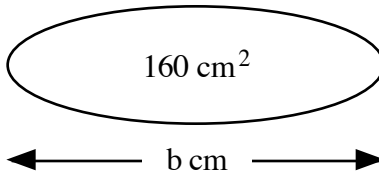
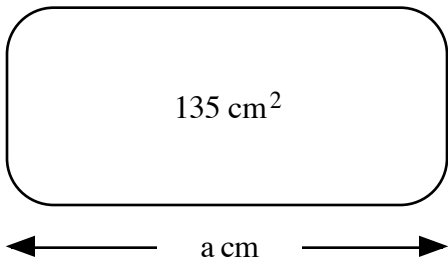
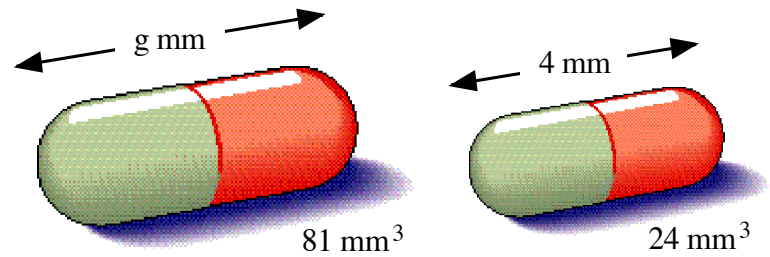
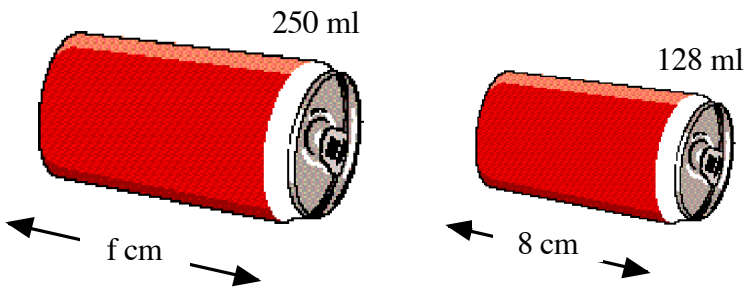
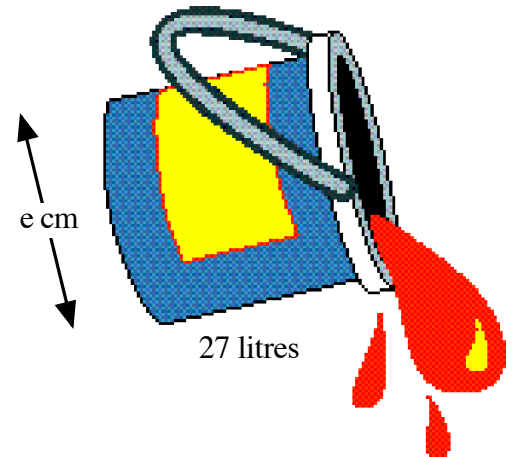
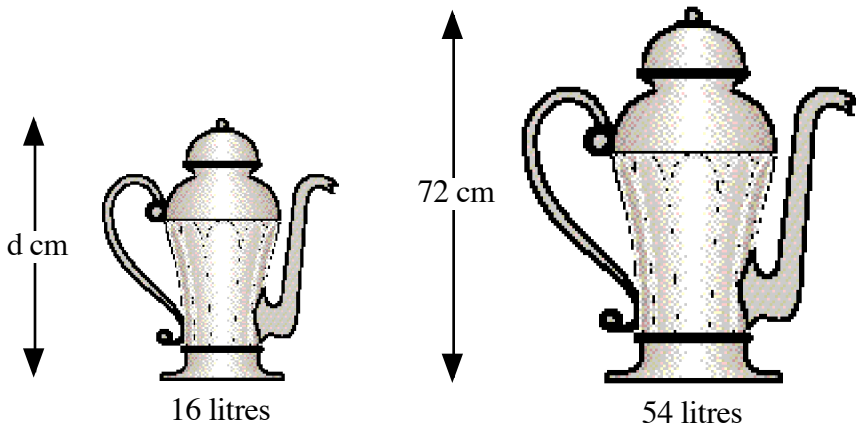
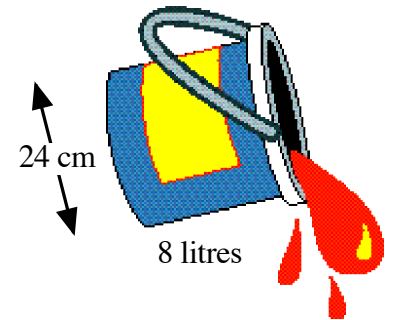
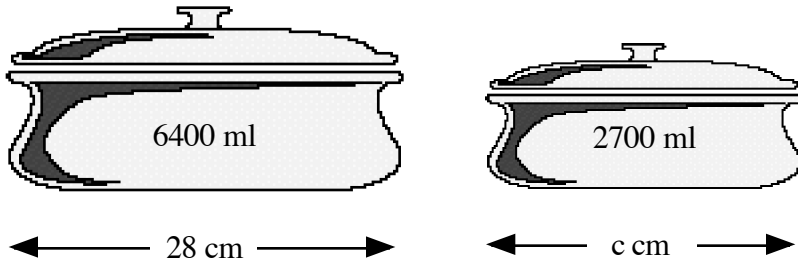
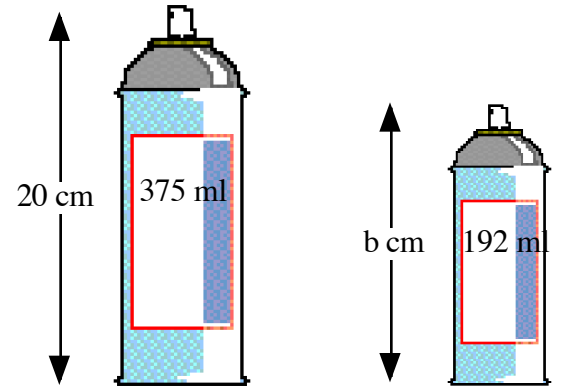
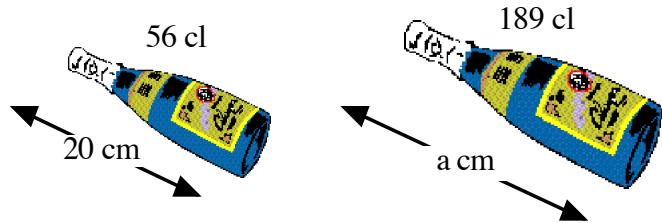

Answers:

1. a = 18 b = 20 c = 24 d = 9 e = 24 f = 28 g = 45

2. a = 30 b = 16 c = 21 d = 48 e = 36 f = 10 g = 6